



HAZET Chiavi poligonali

In acciaio al cromo-vanadio - Esecuzione cromata
Teste lucide

Tipo a profonda curvatura

MISURE METRICHE - DIN 838 - ISO 10104

Apertura 	mm	6x7	8x9	10x11	12x13	13x16	14x15	16x17	16x18	17x19	18x19
Codice	A 3023 ...	0067	0089	1011	1213	1316	1415	1617	1618	1719	1819
A 3023	Cad. €										
Lunghezza totale	mm	165	180	200	220	245	240	255	260	265	275
Apertura 	mm	20x22	21x22	21x23	24x26	24x27	25x28	27x32	30x32	36x41	
Codice	A 3023 ...	2022	2122	2123	2426	2427	2528	2732	3032	3641	
A 3023	Cad. €										
Lunghezza totale	mm	295	295	315	330	340	350	365	365	440	

 6x7÷30x32 mm pz. 10 - 36x41 mm pz. 1

Serie di 8 chiavi (mm 6x7 - 8x9 - 10x11 - 12x13 - 14x15 - 16x17 - 18x19 - 21x22)

In scatola di cartone

Codice	A 3023 8000	A 3023/8	Cad. €	 1
--------	--------------------	-----------------	--------	---

Serie di 10 chiavi

(mm 6x7 - 8x9 - 10x11 - 12x13 - 14x15 - 16x17 - 18x19 - 21x22 - 24x27 - 30x32)

In scatola di cartone

Codice	A 3023 1000	A 3023/10	Cad. €	 1
--------	--------------------	------------------	--------	---



Serie di 12 chiavi

(mm 6x7 - 8x9 - 10x11 - 12x13 - 14x15 - 16x17 - 18x19 - 20x22 - 21x23 - 24x26 - 25x28 - 27x32)

In scatola di cartone

Codice	A 3023 1200	A 3023/12	Cad. €	 1
--------	--------------------	------------------	--------	---

MISURE AMERICANE - ISO 1085

Grandezza	0001	0002	0004	0006	0008	0011	
Codice	A 3025 ...	0001	0002	0004	0006	0008	
A 3025	Cad. €						
Apertura 	pollici	1/4x5/16	3/8x7/16	1/2x9/16	19/32x11/16	5/8x3/4	3/4x7/8
Lunghezza totale	mm	170	200	230	255	265	295
Grandezza	0012	0013	0014	0015	0016	0018	
Codice	A 3025 ...	0012	0013	0014	0015	0016	
A 3025	Cad. €						
Apertura 	pollici	25/32x13/16	13/16x7/8	7/8x15/16	15/16x1	1x1 1/8	1 1/16x1 1/4
Lunghezza totale	mm	295	315	315	330	350	365

 0001÷0012 pz. 10 - 0013÷0018 pz. 5

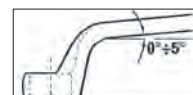

Curvatura profonda



A 3023/10

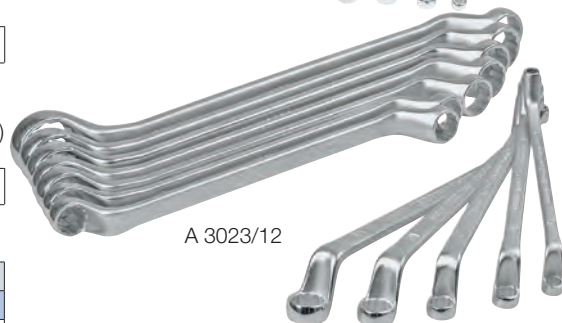

A 3023/12



ABC tools

Tipo per ponteggi

In acciaio al cromo-vanadio, cromata

Impugnatura maggiorata, robusta

Tipo pesante con bocca poligonale  21x22 mm

Adatta per impiego con cordini M 3465/5 e M 3465/7



Codice	A 3094 8000	A 3094/8	Cad. €	 6
--------	--------------------	-----------------	--------	---

A 8 → pag. 97



Tipo diritto con teste disassate

DIN 837 Forma B - ISO 10103

Apertura 	mm	6x7	8x9	10x11	14x15	16x17	18x19	20x22*
Codice	A 3026 ...	0067	0089	1011	1415	1617	1819	2022
A 3026	Cad. €							
Lunghezza totale	mm	100	115	125	162	170	190	210
Apertura 	mm	21x22*	21x23*	24x26*	25x28*	27x32	30x32	
Codice	A 3026 ...	2122	2123	2426	2528	2732	3032	
A 3026	Cad. €							
Lunghezza totale	mm	232	232	254	280	309	324	

 6x7÷30x32 mm pz. 10 - 36x41 mm pz. 1

* Non a norma DIN

Serie di 8 chiavi

(mm 6x7 - 8x9 - 10x11 - 12x13 - 14x15 - 16x17 - 18x19 - 21x22)

In scatola di cartone

Codice	A 3026 8000	A 3026/8	Cad. €	 1
--------	--------------------	-----------------	--------	---

